

AU *l*imate



AULTIMATE MANUAL

REGISTRATION AND MANUAL HOLDER



KNIFE GATE AUL-KG42 or AUL-KG54

MAIN GATE



THIS IS WHERE THE KNIFE GATE LOCKS THE MAIN GATE IN THE CLOSED POSITION. AS SHOWN IN THIS PICTURE THE KNIFE GATE MUST BE RAISED COMPLETELY UP BEFORE THE MAIN GATE CAN OPEN . IF THE PRODUCT IN THE TRAILER IS TO BE UNLOADED THRU THE KNIFE GATE ONLY (LIKE SHELLED CORN, WHEAT , ECT) , SIMPLY DO NOT RAISE THE KNIFE GATE UP PAST THIS POINT AND IT WILL HOLD THE MAIN GATE IN THE CLOSED POSITION. IF THE PRODUCT IN THE TRAILER REQUIRES THAT THE MAIN GATE BE OPENED THE KNIFE GATE MUST FIRST BE RAISED ALL THE WAY TO RELEASE THE MAIN GATE.

(CONTINUED NEXT

PAGE)

GATE OPERATION

2nd Design



THIS SECOND DESIGN ALLOWS THE OPERATOR TO CHOOSE DIFFERENT KNIFE GATE LOCK OPTIONS BY INSTALLING THE HITCH PIN IN DIFFERENT LOCATIONS ON THE LOCK SHAFT . OR REMOVING THE LOCK SHAFT COMPLETELY

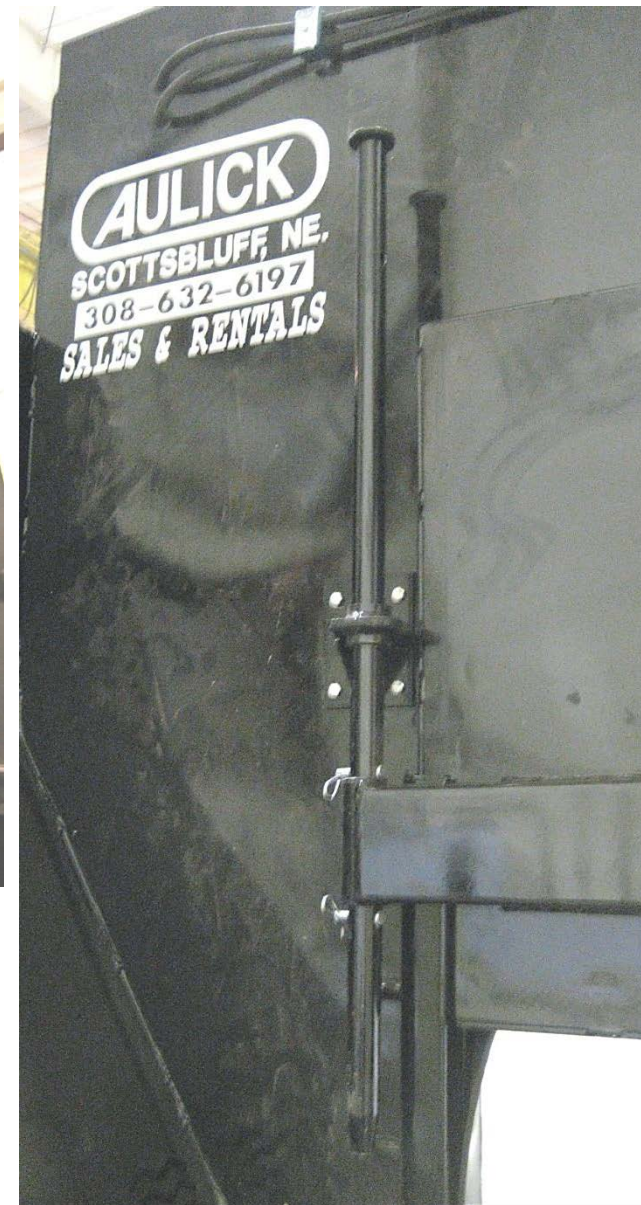

2nd Design



ADJUSTABLE / REMOVABLE GATE LOCKS

Back Gate Rubber Seals

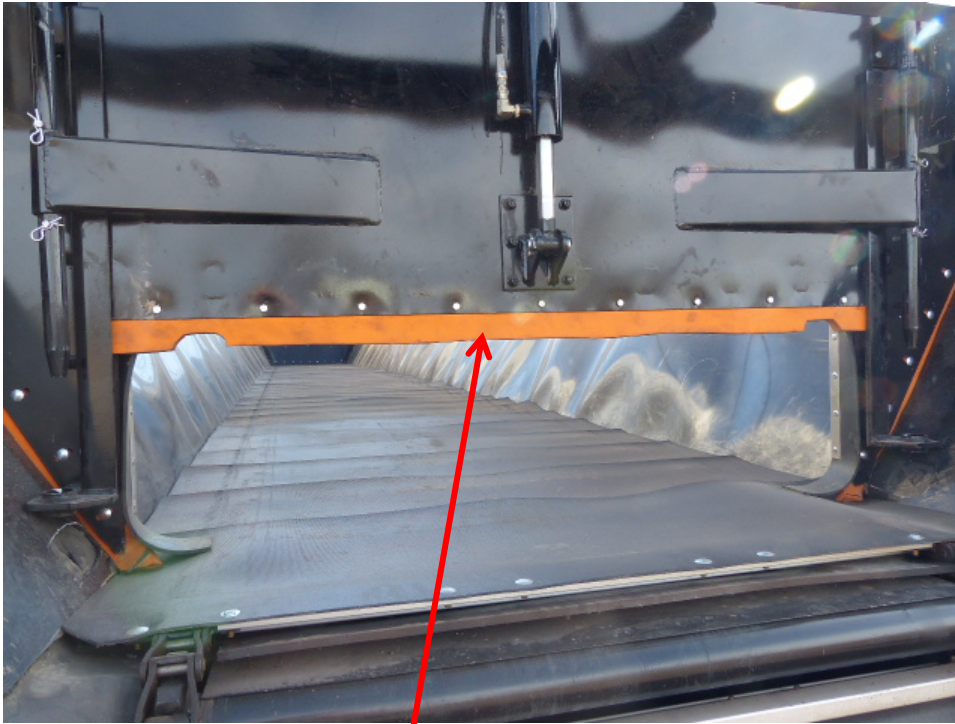

KNIFE GATE RUBBER SEAL
(adjustable/replaceable)

MAIN GATE RUBBER SEAL
(adjustable/replaceable)

WARNING !

THE KNIFE GATE AND / OR MAIN GATE
MUST BE OPEN BEFORE THE BELT IS
TURNED ON OR IMMEDIATE DAMAGE
WILL OCCUR TO THE BELT DRIVE SYSTEM
– REAR GATE AND BELT



MANUAL VALVE PICTURED

1) PULL ON THE KNIFE GATE CONTROL LEVER TO RAISE THE KNIFE GATE

2) PULL ON THE MAIN GATE CONTROL LEVER TO RAISE THE MAIN GATE.

NOTE THAT THE KNIFE GATE MUST BE COMPLETELY UP BEFORE THE MAIN GATE WILL OPEN AS THE EXTENDED LOCKS REMAIN ENGAGED UNTILL THE KNIFE GATE IS ALL THE WAY UP.

3) PULL ON THE BELT CONTROL LEVER TO TURN THE BELT ON (IT WILL STAY ON UNTIL IT IS PUSHED BACK OUT OF THE DETENT)

4) ROTATE THE FLOW CONTROL VALVE CLOCKWISE UNTILL THE BELT SPEED IS AS REQUIRED



CARTRIDGE VALVE

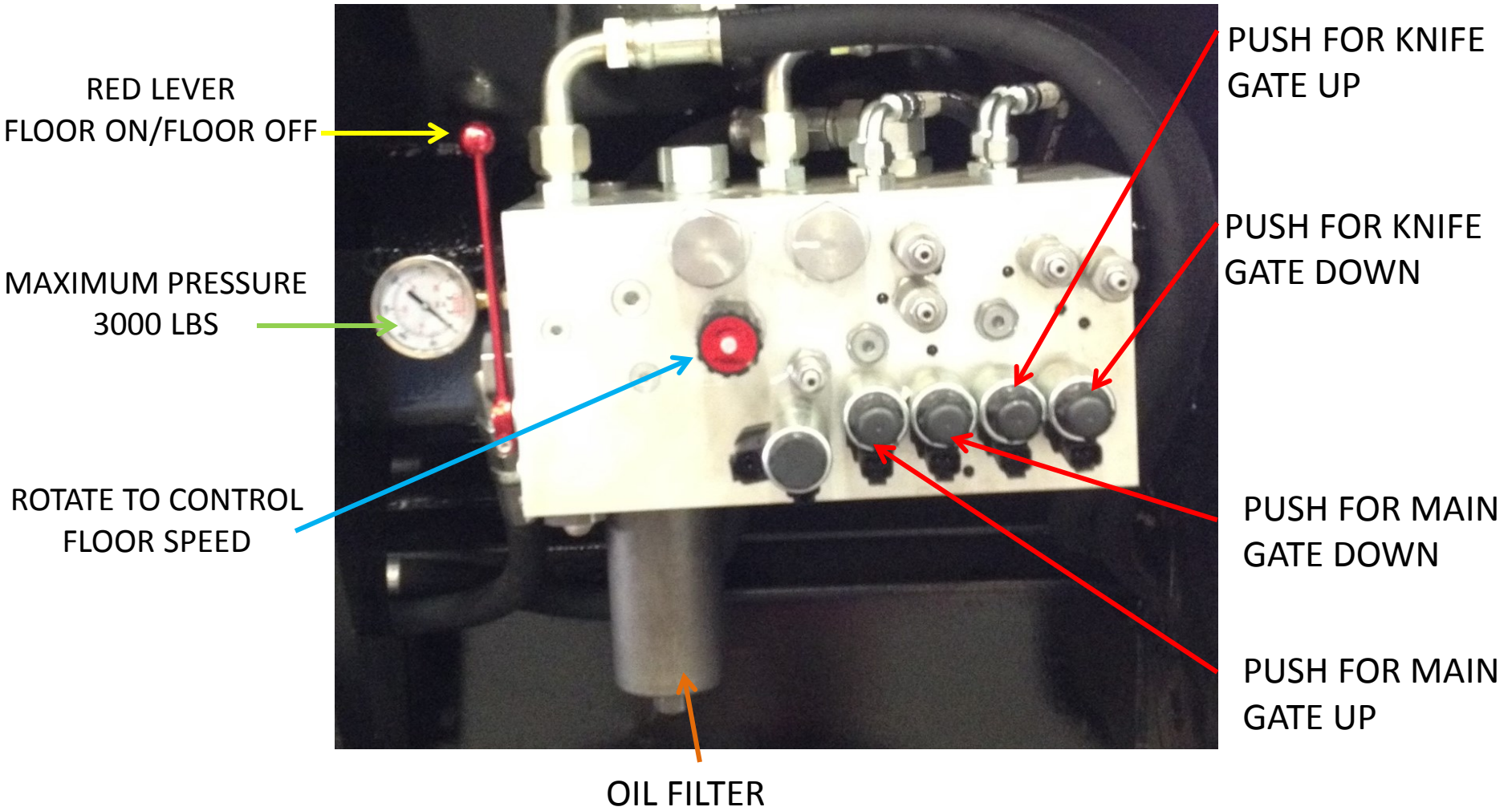

REMOTE RECEIVER

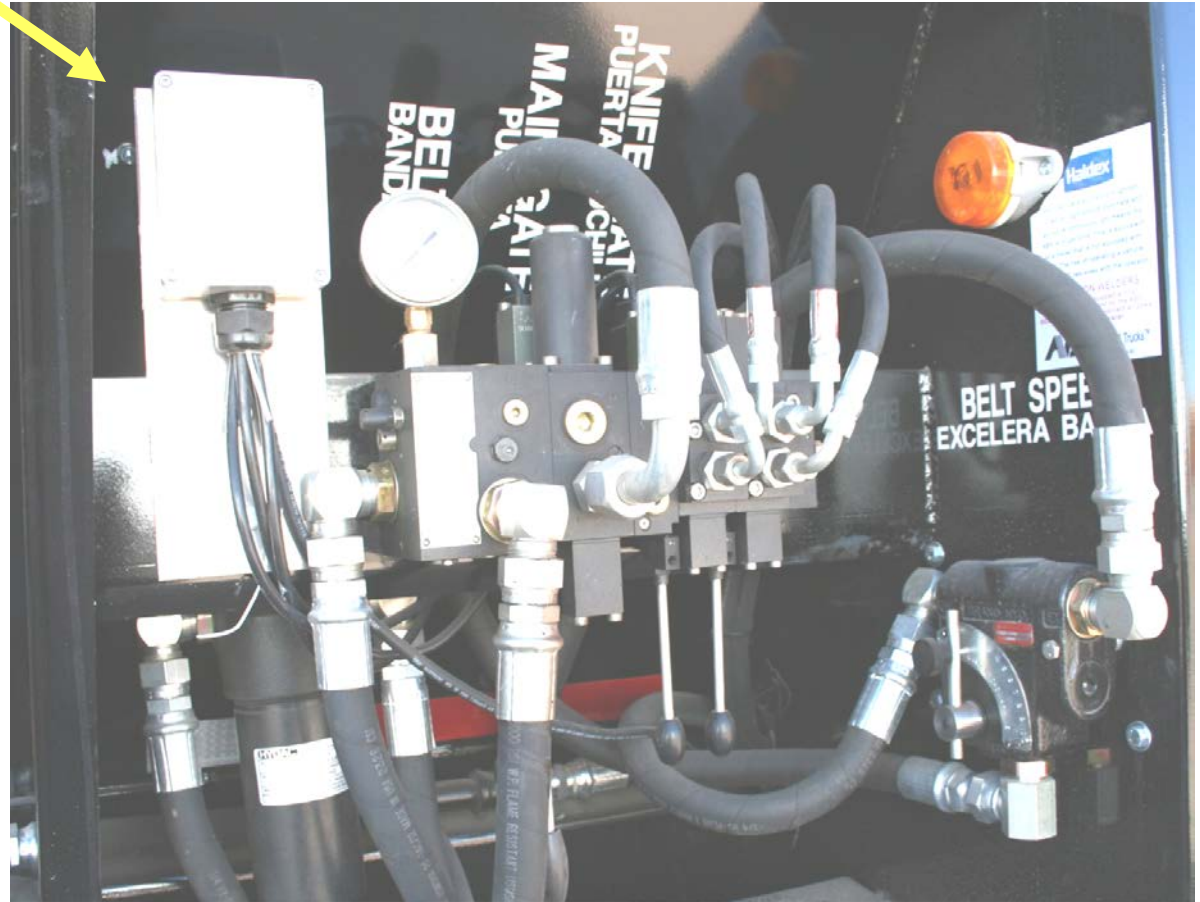

WIRELESS REMOTE WITH HAWE ELECTRIC/MANUAL VALVE

ENABLES OPERATOR TO CONTROL ALL FUNCTIONS OF THE HYDRAULIC SYSTEM REMOTELY . ALSO ALLOWS FOR THE REMOTE OPERATION OF THE REAR FLOOD-LAMPS AND LIFT/TAG AXLE

REMOTE STORED IN PLASTIC CONTAINER MOUNTED ON TRAILER



PRESSURES ON THE GUAGE WILL VARY WITH LOAD AND TEMPERATURE. THE PRESSURES LISTED HERE ARE WHAT YOU SHOULD EXPECT TO SEE UNDER “NORMAL” CONDITIONS . THE SYSTEM RELIEF VALVE IS SET AT 3000 P S I



SYSTEM ON 500 PSI
KNIFE GATE UP 2700 P S I
KNIFE GATE DOWN 1000 P S I
MAIN GATE UP 2700 P S I
MAIN GATE DOWN 1500 P S I
BELT ON 1000-2700 PSI

THE TRUCK NEEDS TO SUPPLY A MINIMUM OF 20 GPM AT 3000 PSI

MAIN GATE RELIEF VALVE ADJUSTMENT /HAWE VALVE

MAIN GATE PRESSURE RELIEF VALVE ADJUSTMENT

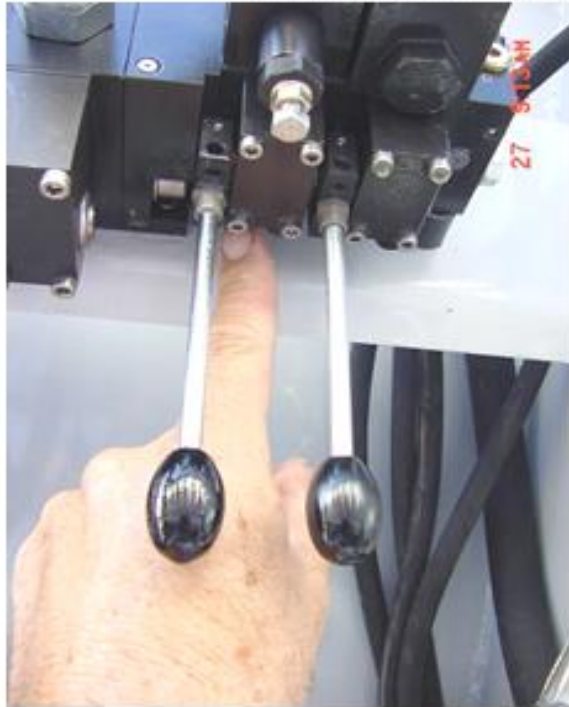

There are 2 relief valves located behind the center lever on the valve

(Main gate control)

NOTE :This adjustment can be done without removing the valve



1) To adjust them remove the black metal cap and washer

Tools Required: # 12 deep metric socket
6 Allen wrench

View of Back of valve, (opposite hoses)

2) Loosen the lock nut on the screw and turn the screw - in - to increase the gate cylinder pressure

A) Relief toward the rear of trailer is pressure down

B) Relief toward the front is pressure up

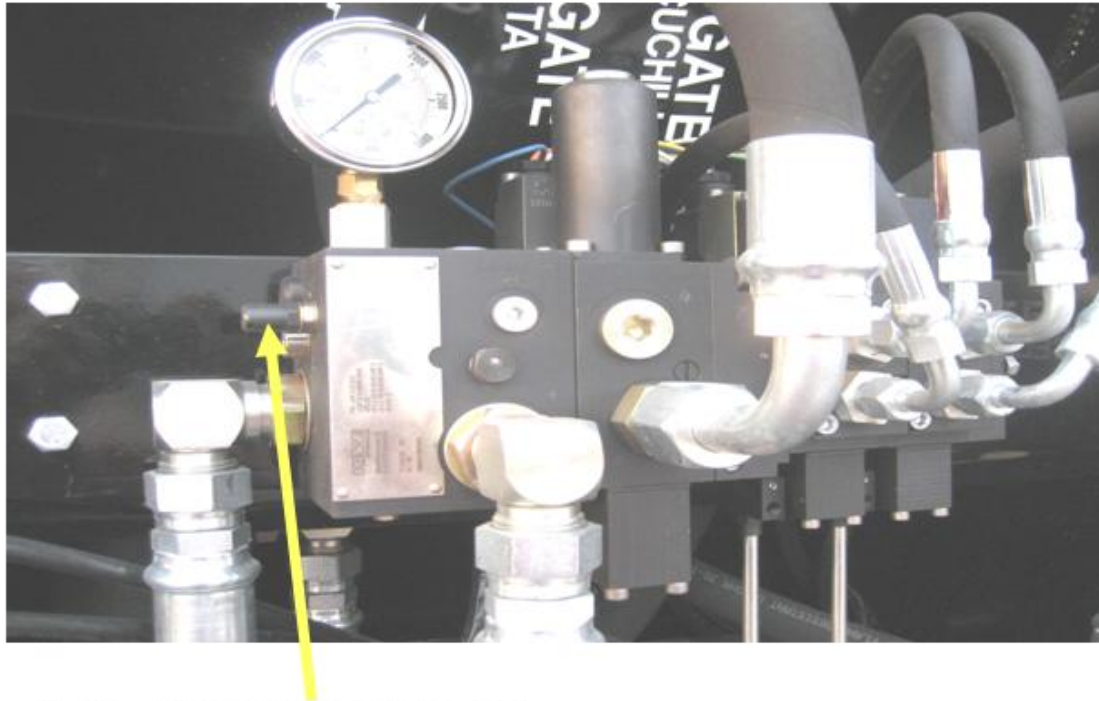

Main system relief valve

Remove cap , loosen lock nut

Turn screw in (CW) to increase pressure

Turn screw out (CCW) to decrease pressure

If there is no change while adjusting this relief , the truck relief valve and pump should be checked

HAVE VALVE

To check the relief valve setting of the hydraulic system :

- 1) Pull out on the knife gate control handle**
- 2) Run the knife gate up until it bottoms the cylinder**
- 3) Continue to hold the knife gate control in the up position and observe the pressure on the gauge .**
- 4) Normal relief pressure should be approximately 2800-3000 PSI**

HAWE Electric valve detent

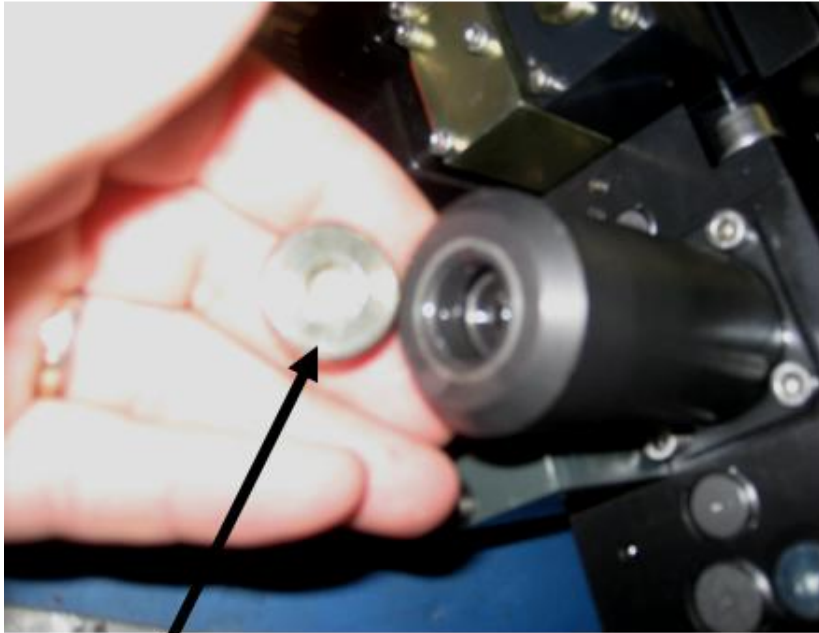

1) Remove the cap with a number 8 metric Allen wrench

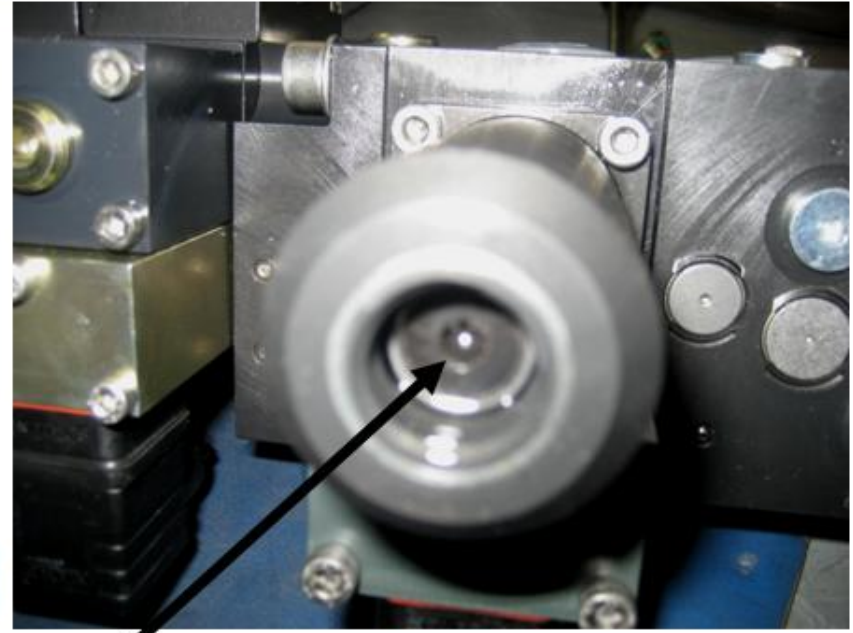

2) Tighten up the screw on the end of the spool that holds the spring and detent in place . It takes a number 4 Metric Allen wrench (the screw turns hard) turn the screw until it bottoms and is tight



Detent



**HIGH PRESSURE HYDRAULIC FILTER CONTAMINATION
SERVICE FILTER ANNUALLY , WRITE DATE ON OUTSIDE WITH
PERMANENT MARKER**



BELT ADJUSTMENT :

TO TIGHTEN THE BELT , MOVE THE LOCK OFF AND TO THE SIDE ,
TURN THE ADJUSTING NUT CLOCKWISE UNTIL THE BELT IS BACK UP TO THE
ADJUSTMENT ROD LOCATED IN THE CENTER OF THE TRAILER , TAKE UP BOTH SIDES
EVENLY MAKING SURE THE TAKE UP ASSEMBLY IS SQUARE WITH THE TRAILER

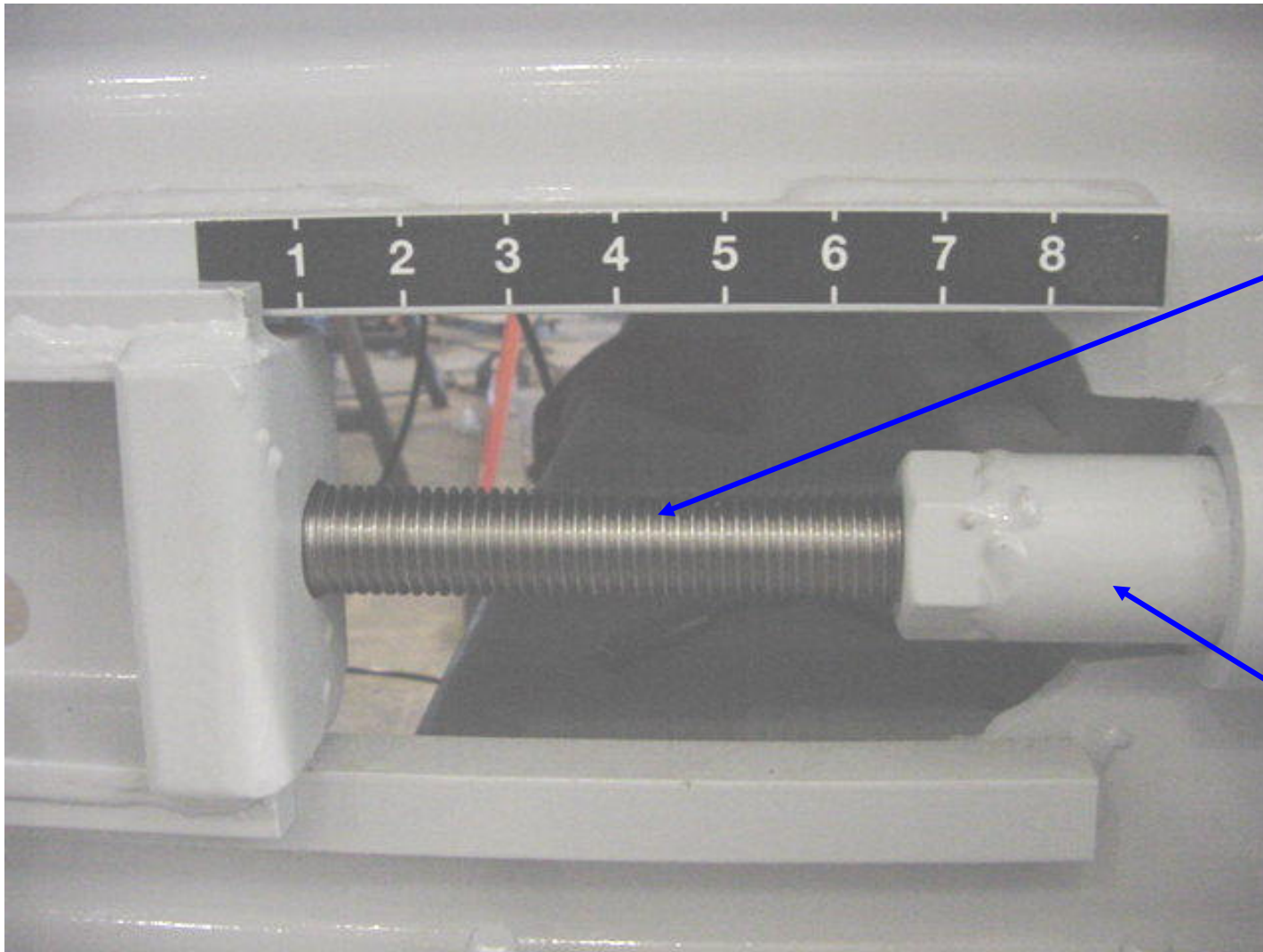

Aul-ssbolt

Aul-chain adj

Aul washer

**ADJUST THE FRONT TAKE UP EVENLY FROM SIDE TO SIDE
TO KEEP THE TAKE UP ASSEMBLY SQUARE WITH THE
FRONT OF THE TRAILER**



88C CHAIN
CONNECTOR
Aul-L9603

**THIS IS THE REFERENCE ROD TO ADJUST THE CHAIN , PROPER
ADJUSTMENT RANGE IS APPROXIMATELY 1.5 INCH'S ABOVE
OR BELOW THE CENTER OF THE CHAIN**

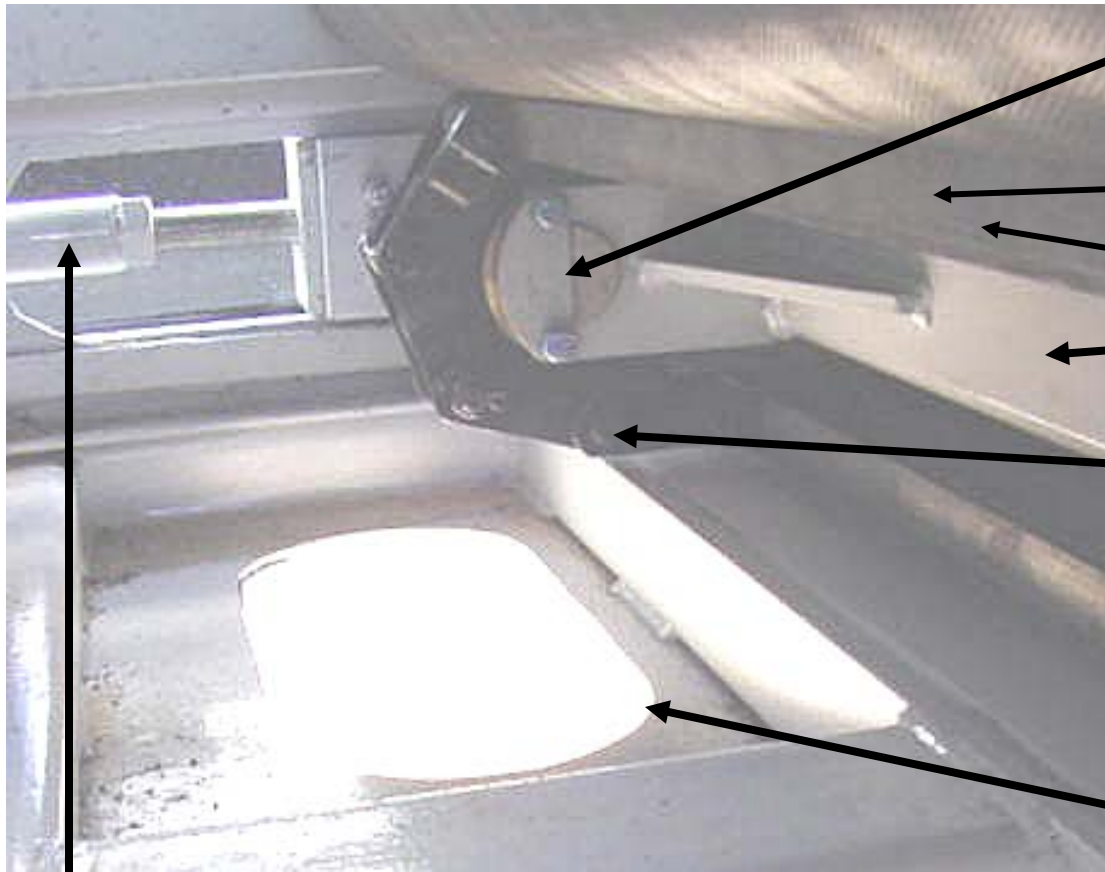

FRONT IDLER BEARING ,
SPROCKET AND WASHERS

Aul-41channel or

Aul-54channel

TAKE-UP WELDMENT

88HD PINTLE CHAIN
LUBRICATE WITH
MOTOR OR
HYDRAULIC OIL

WASH OUT OPENINGS IN 5TH
WHEEL PLATE

TAKE-UP ADJUSTER BOLT AND SLEEVE
ASSEMBLY (stainless steel)

FRONT TAKE-UP ASSEMBLY

(INFORMATION ONLY)

(CONTINUED NEXT PAGE) 6

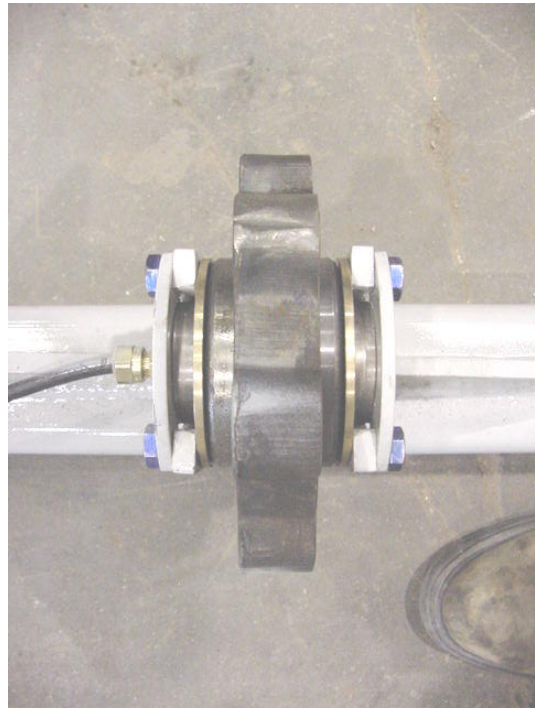

FRONT TAKE-UP ASSEMBLY

(information only)

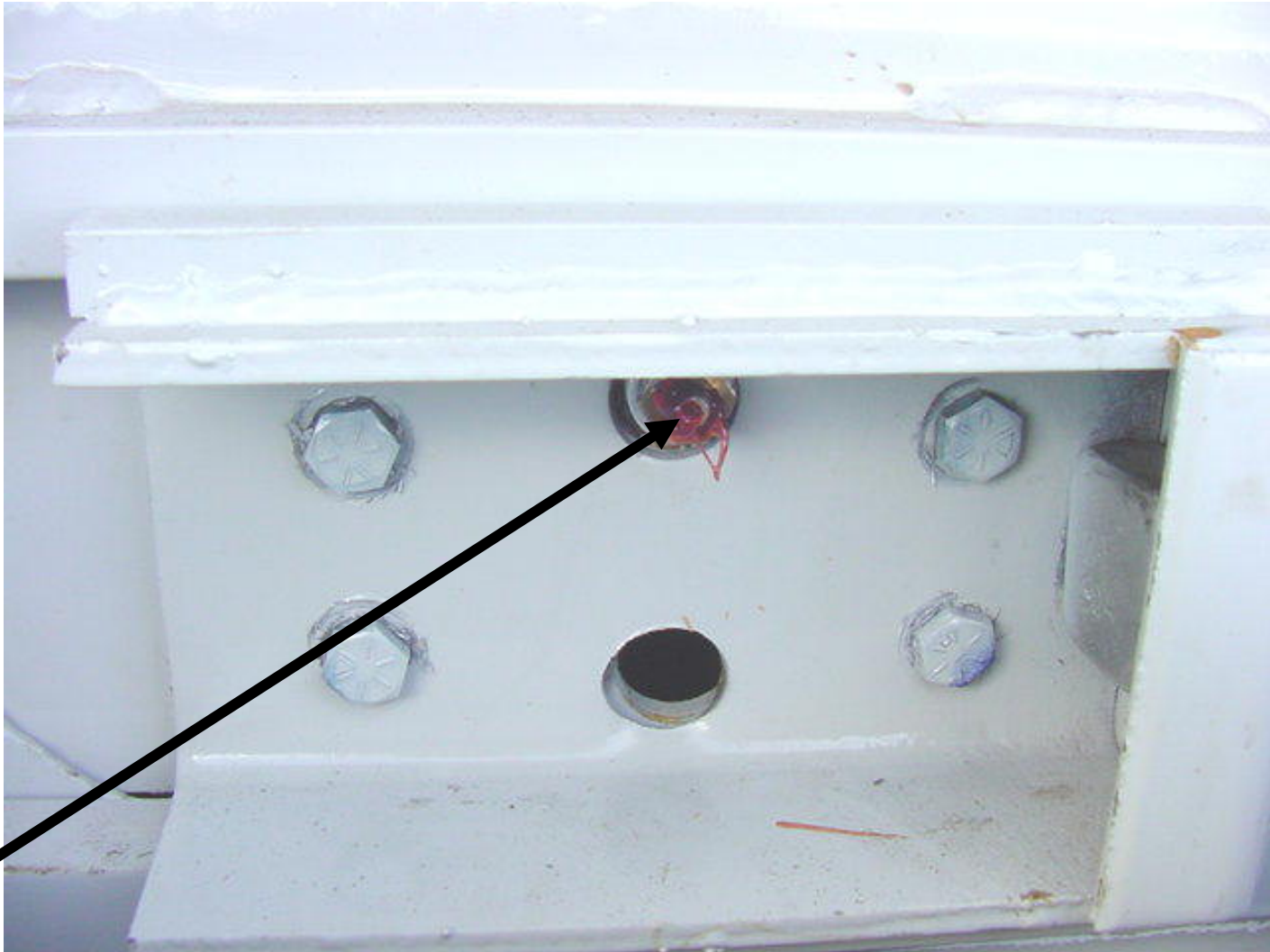

**FRONT TAKE-UP BEARINGS ARE GREASED HERE;
ONE ON BOTH SIDES : GREASE WEEKLY**

1st Design



**REAR BEARING GREASE ZERK, GREASE WEEKLY
PART NUMBER – AUL-BEARING**

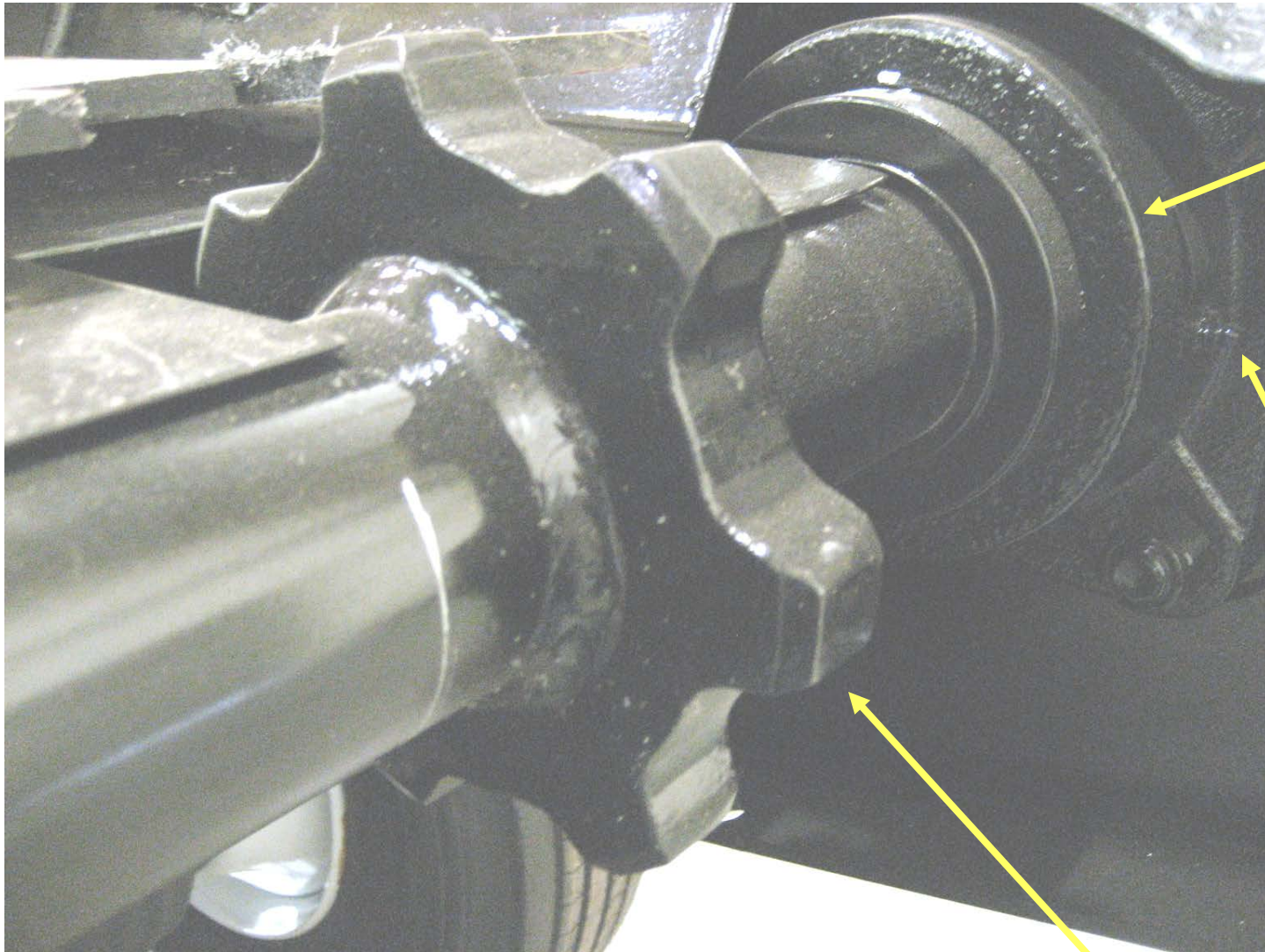

REAR
BEARING

2ND DESIGN

GREASEZERK

DRIVE SPROCKET / 2ND DESIGN

PATENTED SPROCKETS

DRIVES 88 C CHAIN

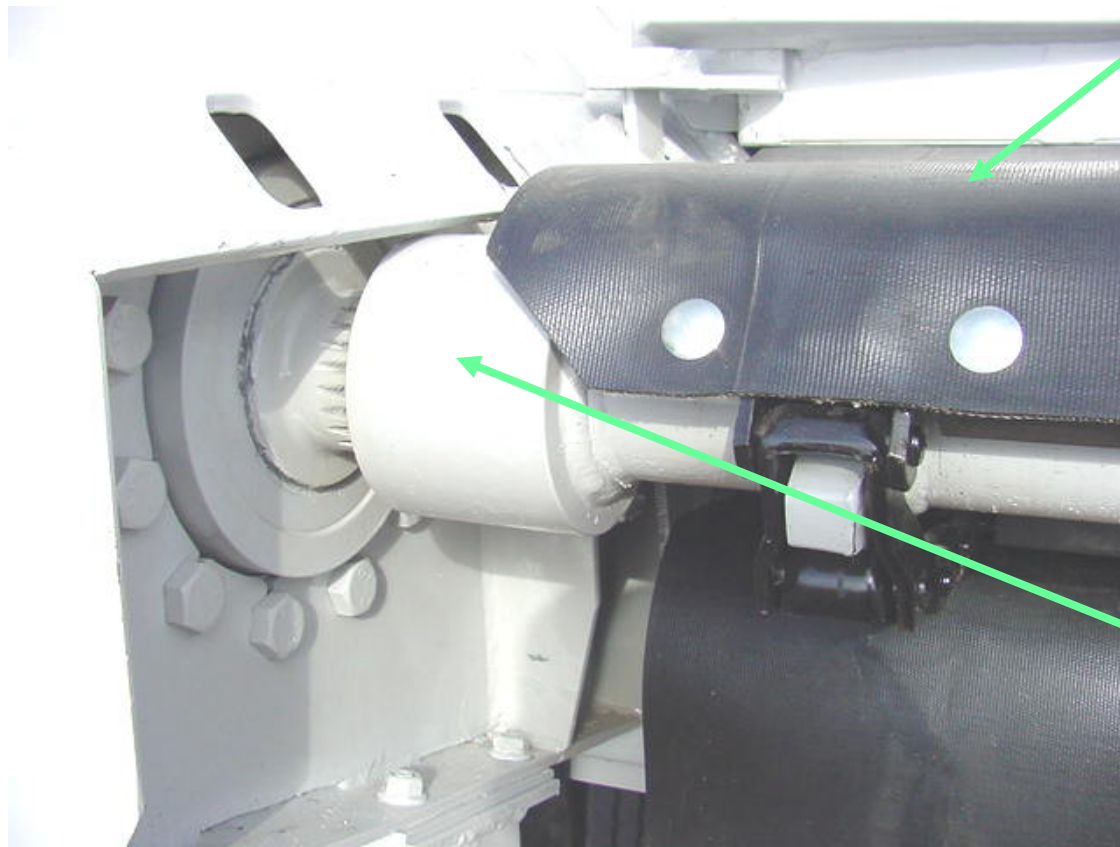

FLAP

54 INCH BELT

Aul-54 flap

REAR DRIVE SHAFT
WELDMENT ASSEMBLY

54 INCH BELT Aul-rs54

REAR DRIVE SHAFT

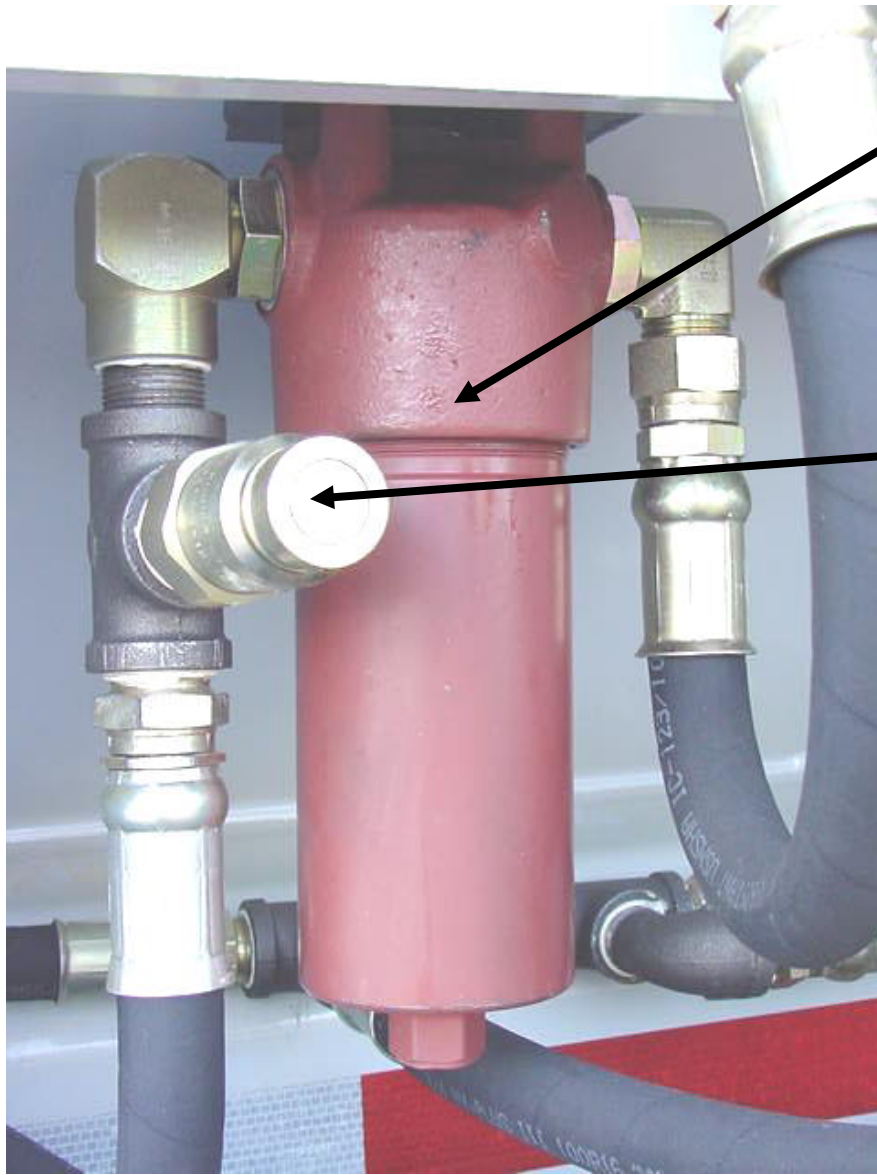

HIGH PRESSURE THREADED
HYDRAULIC OIL FILTER

AUL-02080661

ELEMENT IS AUL-075D020

REAR PRESSURE COUPLER

FD89-1002-12-12

FOR EXTERNAL HYDRAULIC FEED
(optional)

NOTE: This filter is intended as a
secondary filter only , the wet kit on
the truck must have a full flow filter

PRESSURE HYDRAULIC OIL FILTER

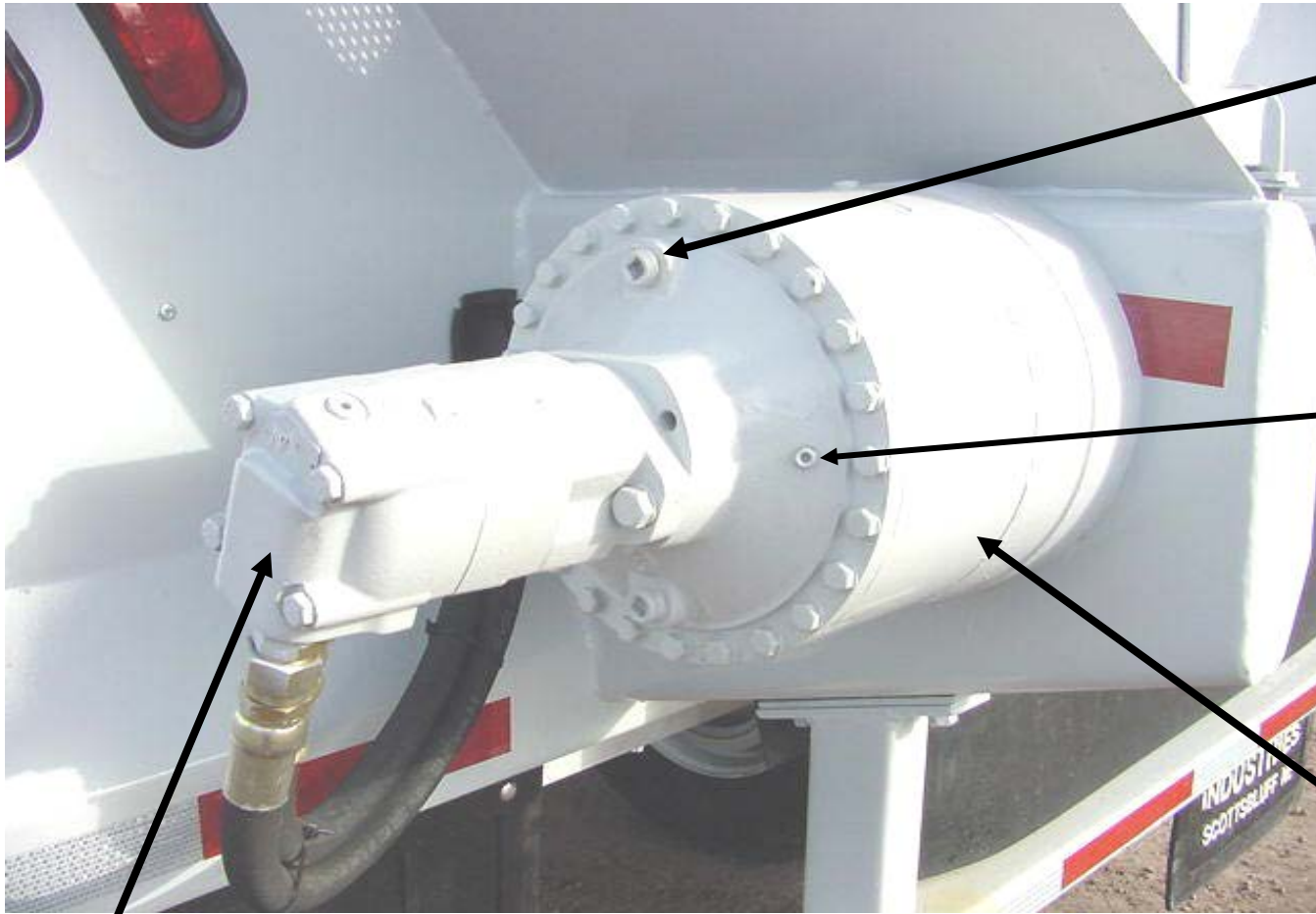

FILL HOLE

USE 80/90 GEAR OIL

OIL LEVEL HOLE

CHECK
MONTHLY

REAR DRIVE UNIT , AUBURN

CHAR-LYNN AUL-104-1032

2ND DESIGN REAR DRIVE UNIT ESKRIDGE

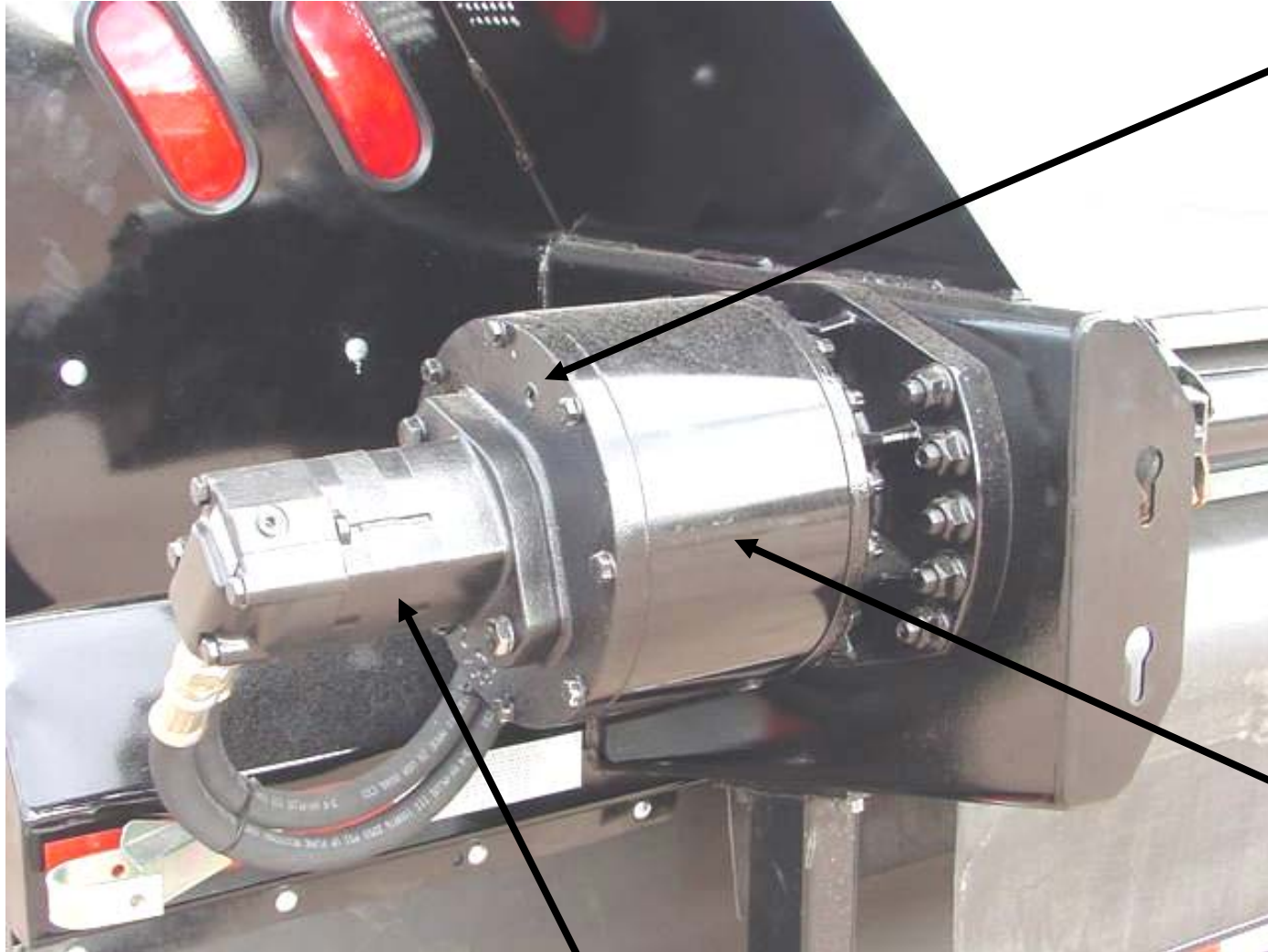

FILL HOLE / FULL
LEVEL

80/90WT

REAR DRIVE
UNIT , Eskridge

CHAR LYNN 104-1196

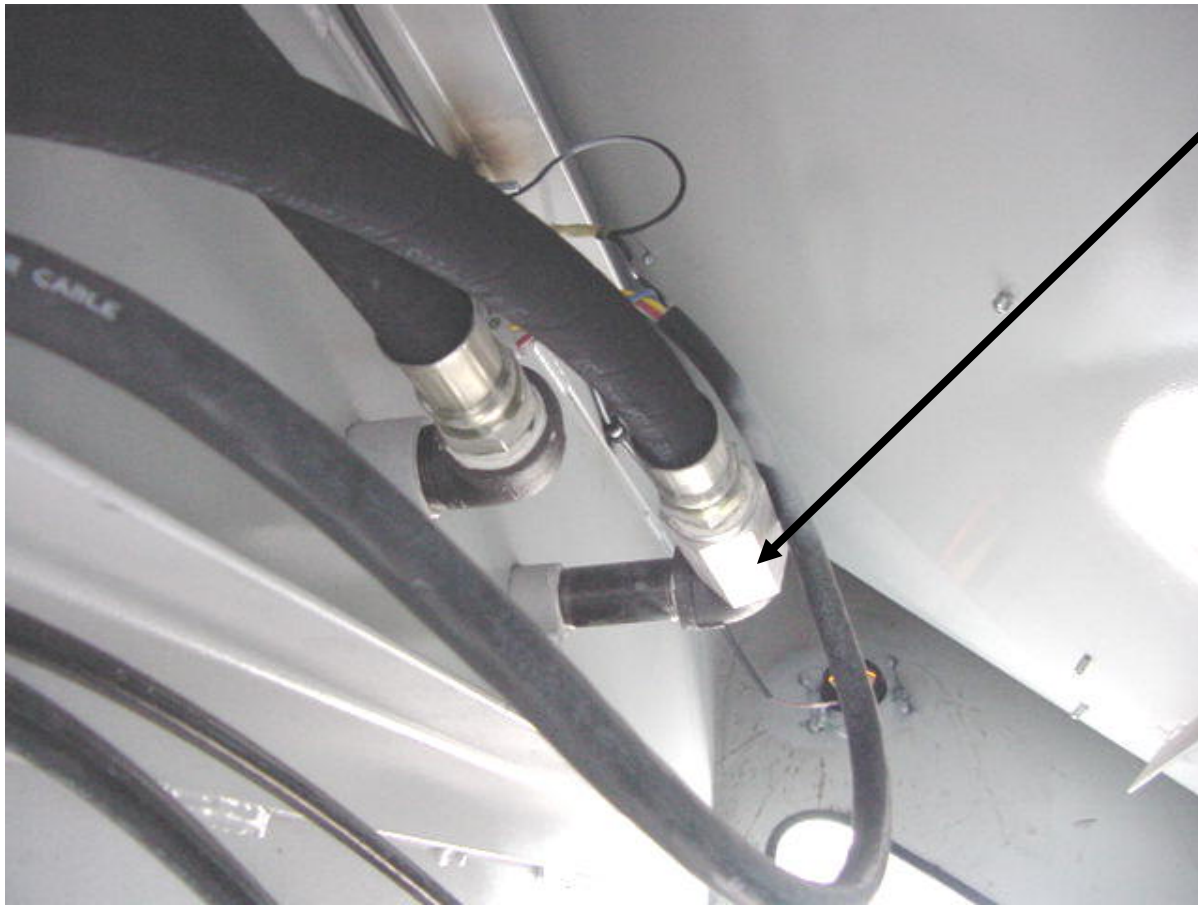

RETURN LINE CHECK VALVE
(TO PROTECT THE HYDRAULIC
SYSTEM FROM REVERSE OIL FLOW
IF THE QUICK COUPLERS ARE
HOOKED UP BACKWARDS)

RETURN LINE CHECK VALVE

(LOCATED INSIDE THE FRONT OF THE TRAILER BULKHEAD , ABOVE
THE FRONT BELT TAKE-UP WELDMENT)

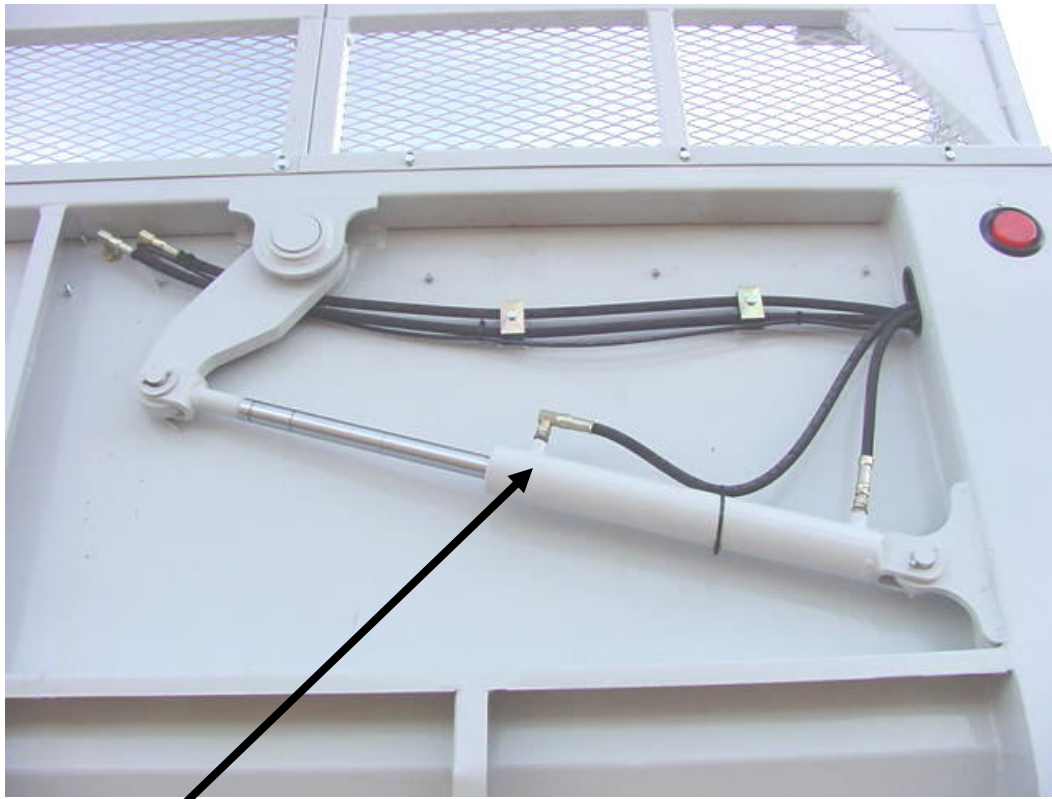

2 X 14 LIFT GATE CYLINDER AUL-3532 2-REQUIRED



2.0 X 20 KNIFE GATE CYLINDER AUL-3723 1-REQUIRED

REAR GATE HYDRAULIC CYLINDERS



**LED LIGHTS
STANDARD**



ALL AXLES ARE 25000 LB HENDRICKSON INTRAAX

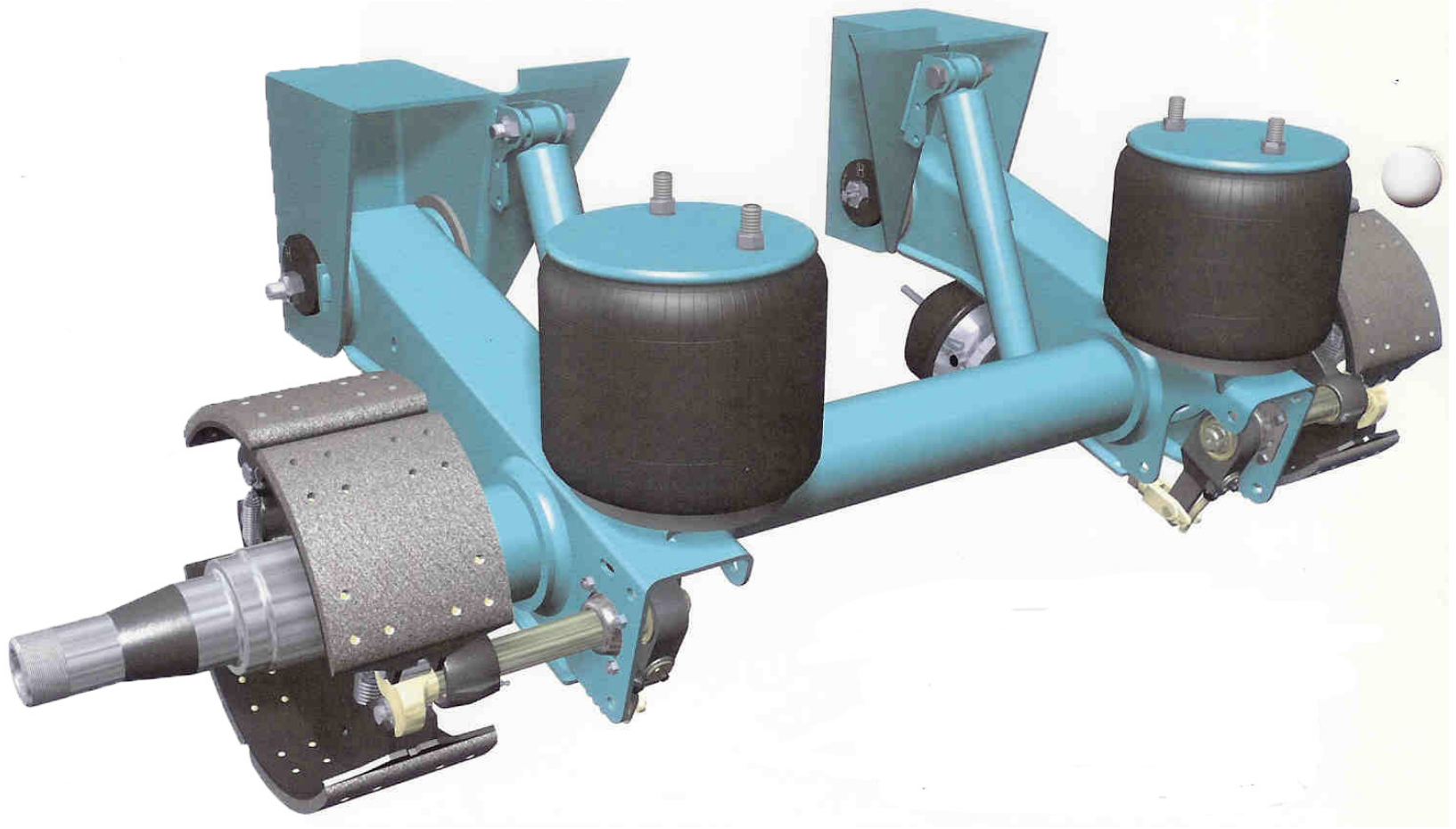

MODEL AA230T/AA250T INTRAAX® cont.



PARTS LIST — SUSPENSION AND AXLE COMPONENTS
MODEL AA230T/AA250T INTRAAX® cont.

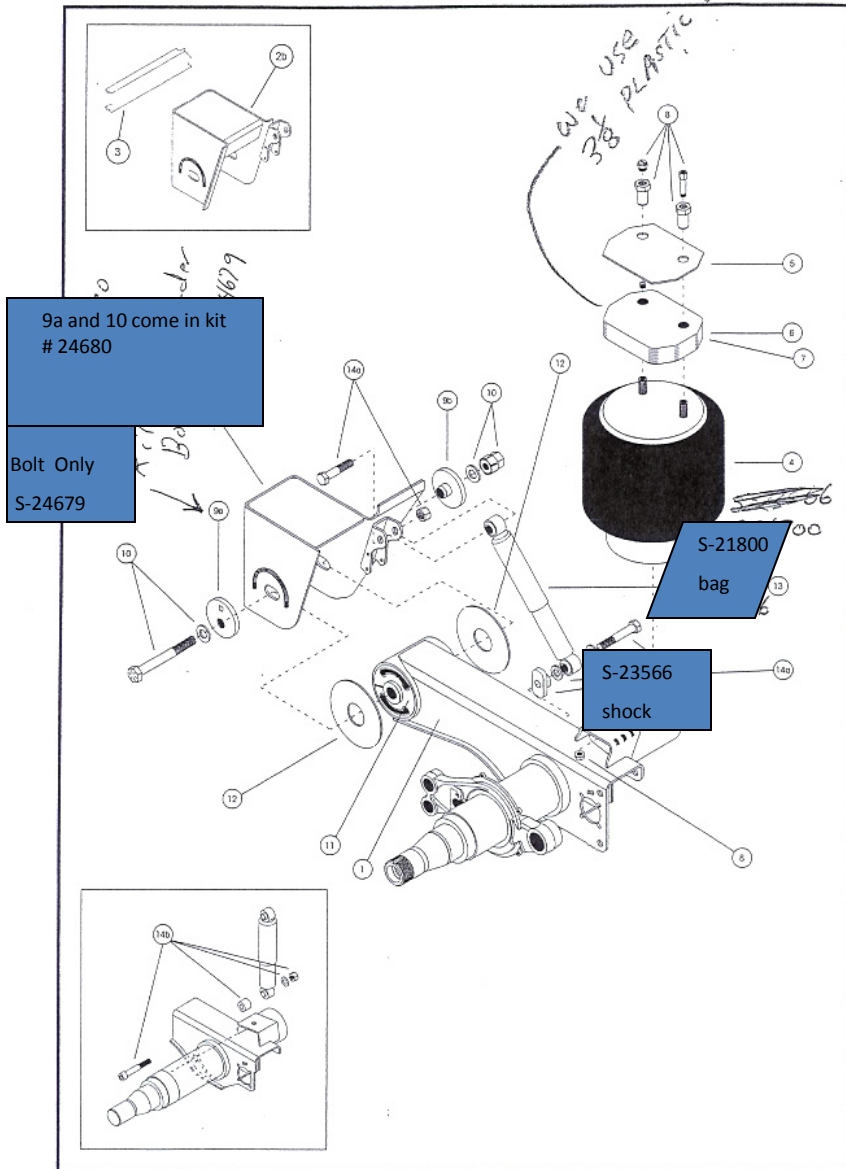

ITEM	DESCRIPTION	PART NO.	QTY	NOTE
8	AIR SPRING MOUNTING KIT ² (Per Air Spring)	S-22619/2	2	For units with no spacer or with 1-5/16", 2-1/16", 3-5/16", 4-1/16", 4-5/16", 5-5/16" or 5-9/16" thick spacer assemblies
		S-22630/2	2	For units with a 1-1/8" thick spacer
		S-22631/2	2	For units with a 1-7/8" thick spacer
		S-22632/2	2	For units with a 3-1/8" thick spacer
				<i>AUL-5-22632/2</i>
9	ALIGNMENT COLLARS			
9a	Eccentric, QUIK-ALIGN®	S-20925	2	Pivot bolt hole is offset from center of collar
9b	Concentric, QUIK-ALIGN®	S-20924	2	Pivot bolt hole is in center of collar
10	QUIK-ALIGN® PIVOT BOLT KIT ²	S-21052	2	Includes bolt, TORQ-RITE® Nut and washers
11	QUIK-ALIGN® PIVOT BUSHING KIT ²			
	Standard	S-21166	2	Includes bushing, pivot bolt kit, wear pads and tube
	High Control	S-24112	2	Includes bushing, pivot bolt kit, wear pads and tube
12	BUSHING WEAR PAD			
	Standard	S-11613	4	Four (4) required per axle
	High Control	B-21099	4	Four (4) required per axle
13	SHOCK ABSORBER ³			
	Standard Duty	S-23566	2	Use to replace A-20002 or B-23566 shock absorbers
	Extended Service	S-24125	2	Use to replace A-20126 or B-24125 shock absorbers
	Extended Service, High Damping	S-24023	2	Use to replace B-21553 or B-24023 shock absorbers
	Limited Rebound	S-23361	2	Use to replace B-22345 or B-23361 shock absorbers
14	SHOCK ABSORBER BOLT KIT ²			
14a	For Units Shipped After 8/11/95	S-24021 ⁴	2	One (1) required per shock
14b	For Units Shipped Before 8/11/95	S-20896/2	2	One (1) required per shock

² See AA230T/AA250T INTRAAX® Kit Components Section or Service Kits Section for kit breakdown.

³ Other options exist. Contact Hendrickson for assistance.

⁴ Picture depicted may not resemble all models. This kit contains components necessary to repair AA230T/250T INTRAAX® models manufactured after 8/11/95.

**HENDRICKSON INTRAAX
AA230T
PARTS LIST**



**HENDRICKSON
INTRAAX PARTS**

PAGE 2

**BRAKE SHOES – 16.5 X 7
S-CAMS- 20 5/8 INCH
BRAKE CHAMBERS –BTS30/30-45
WHEEL SEAL – 370025
WHEEL BEARINGS – HM218248/HM212049
AXLE-25000 LB / 77.5 TRACK
AUTOMATIC SLACK ADJUSTER-65175P
HUB CAP –84009
BRAKE DRUM -65719**

HALDEX AIR LEVELING VALVE FOR AIR RIDE HENDRICKSON INTRAAX AND WATSON-CHALIN SUSPENSION'S

Type PR Height Control Valve

Precision Response
Height Control Valve
for any Truck, Trailer,
Industrial or
Recreational Vehicle
Air Suspension



90554945

Features and Benefits:

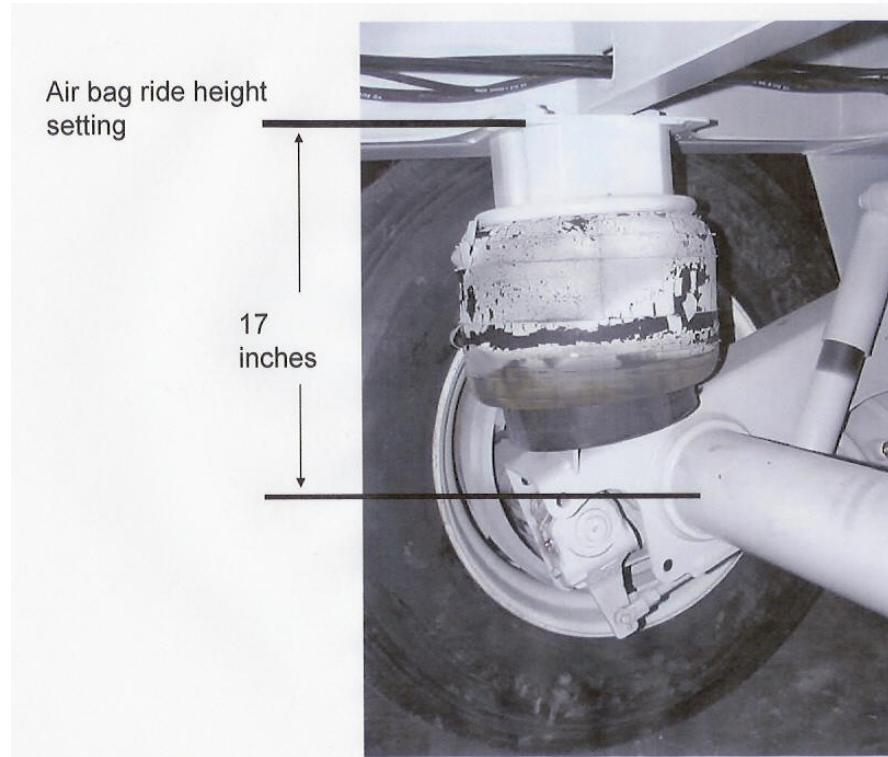



**HD LANDING GEAR
RATED FOR 50000 POUNDS
PART NUMBER PDC-KIC-168**

TRAILER WIRING

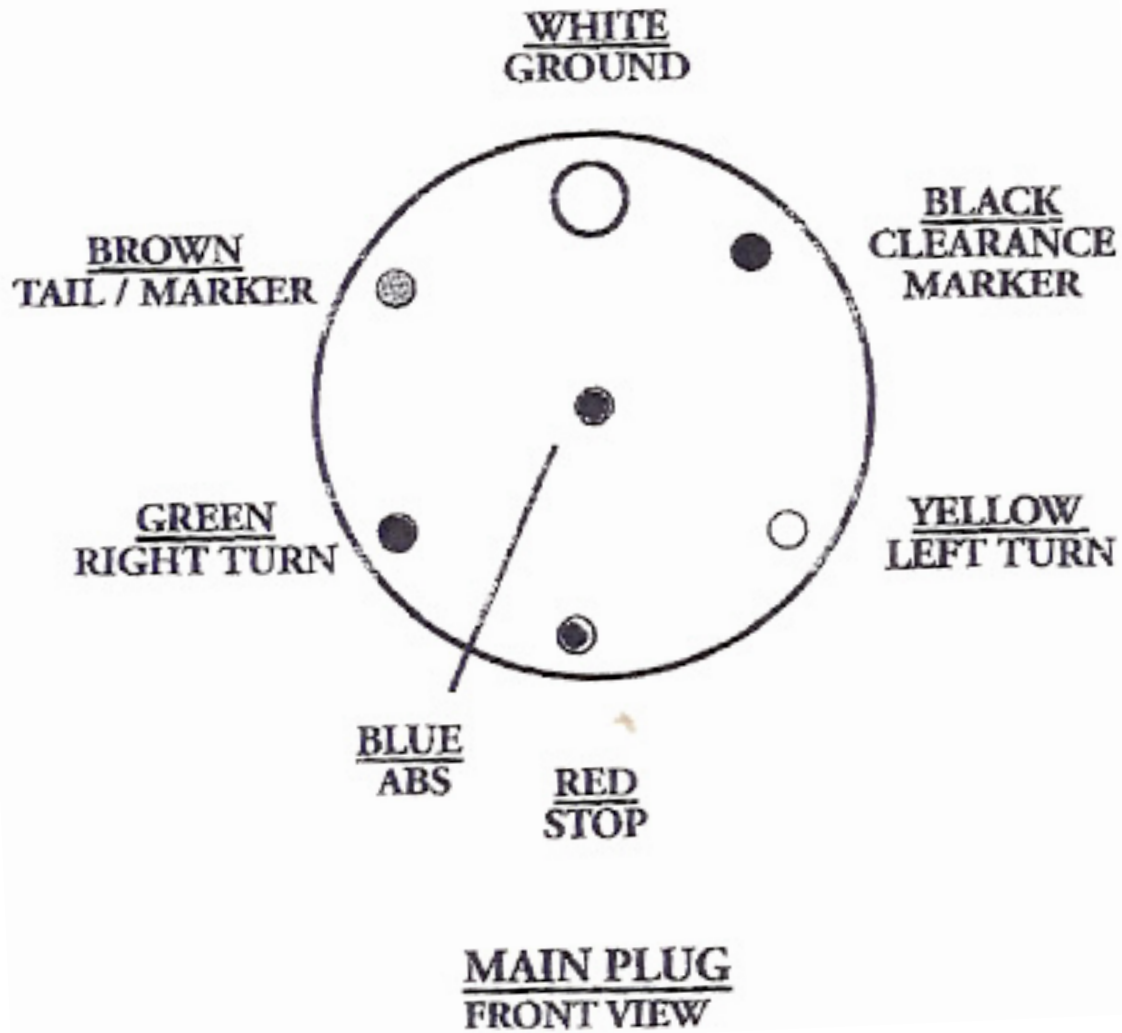

Ground Clearance Left turn Stop Right turn Tail Aux 12 Volt +

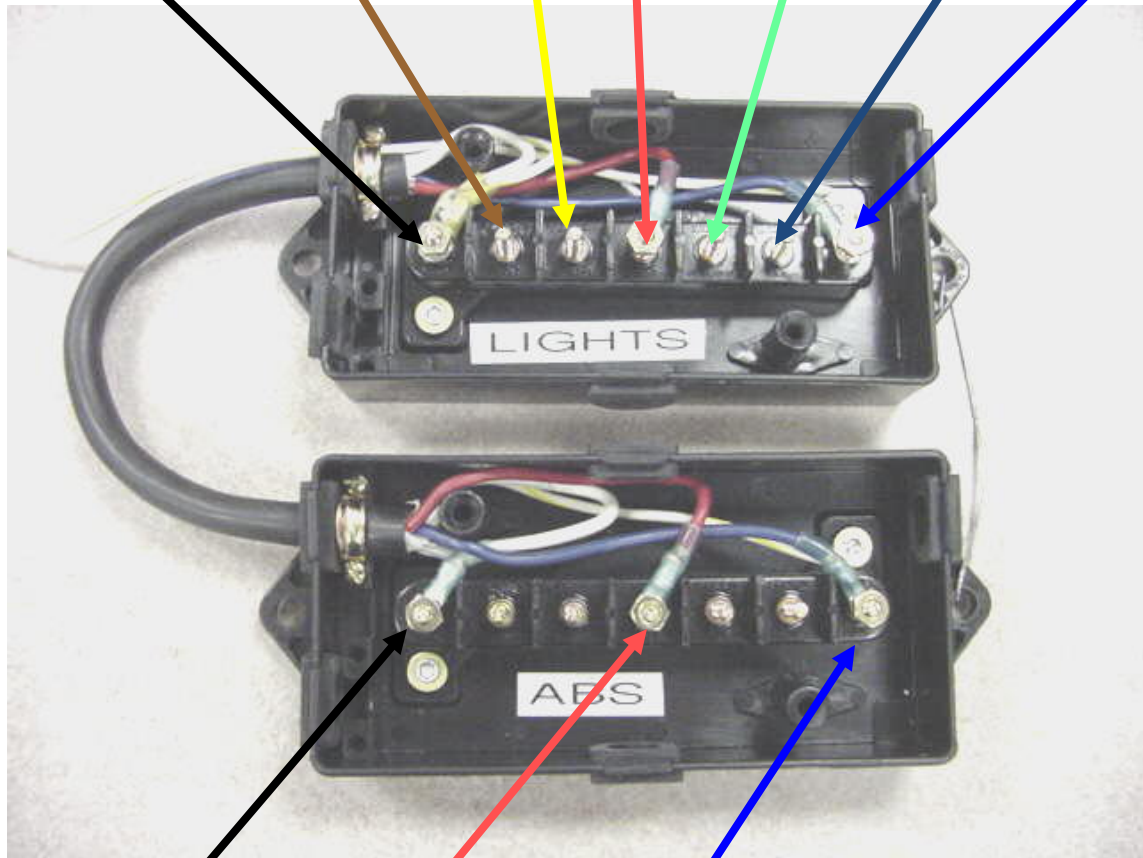

THESE ELECTRICAL JUNCTION BOXES ARE LOCATED INSIDE THE LEFT REAR SECTION OF THE TRAILER , BEHIND THE ACCESS DOOR



Ground Stop Aux 12 Volt +

TRAILER LIGHTS AND ABS JUNCTION BOXES

PLC, PLC Plus, & PLC Select **Haldex**

2S/1M System Wiring - PLC Select

2S/1M System Wiring:

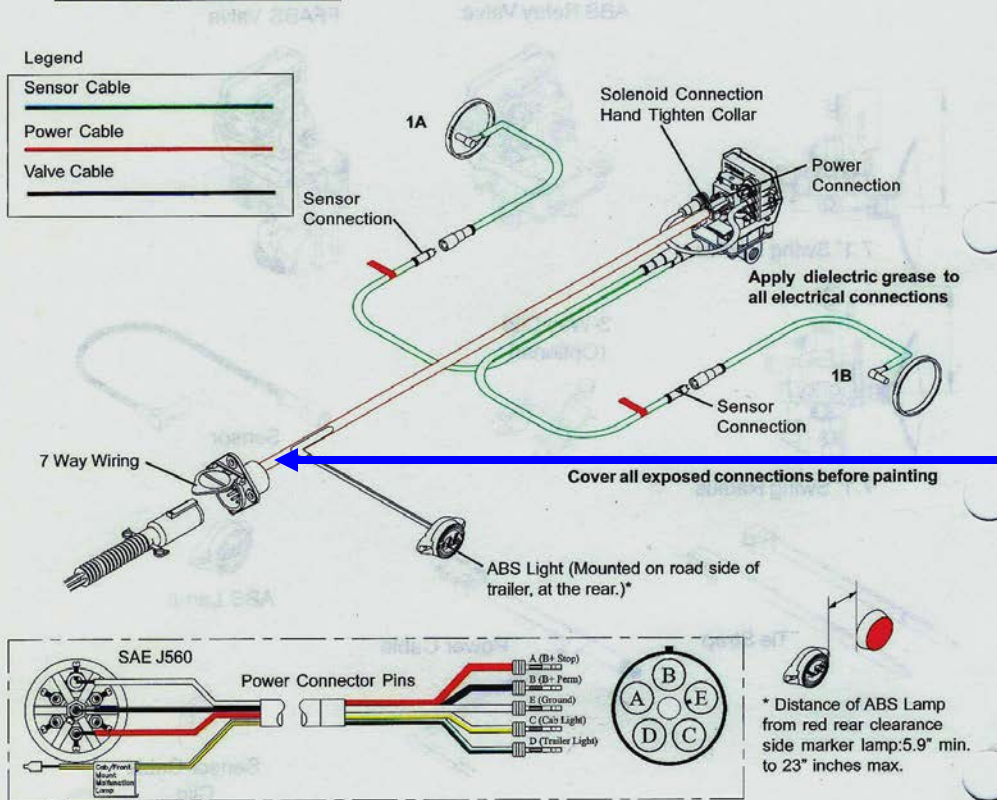

Note:

Federal regulations require that new trailers, starting 3/1/2001, have the capability to provide an ABS fault signal from the trailer ABS into the tractor. Haldex provides two (2) options for this, one is through Industry standard "PLC 4 Trucks" multiplexing (the signal is carried on Pin 7), and the other is a hard wire (through Pin C of the power connector via the ISO 3731 connector). The requirement for the trailer mounted ABS lamp remains in effect until March of 2009.

HALDEX

A B S SYSTEM WIRING

NOTE: THE 12 VOLT + FEED WIRE (BLUE) AND THE BRAKE LIGHT SENSING WIRE (RED) AND THE GROUND (WHITE) ARE IN THE ABS WIRING JUNCTION BOX INSIDE THE REAR OF THE TRAILER, LEFT SIDE, BELOW THE TRAILER LIGHT WIRING JUNCTION BOX. (they are not wired to the front of the trailer as shown here, but are connected to the front plug via the main wiring harness from the rear)

HALDEX ABS BRAKE VALVE AUL-AQ960102

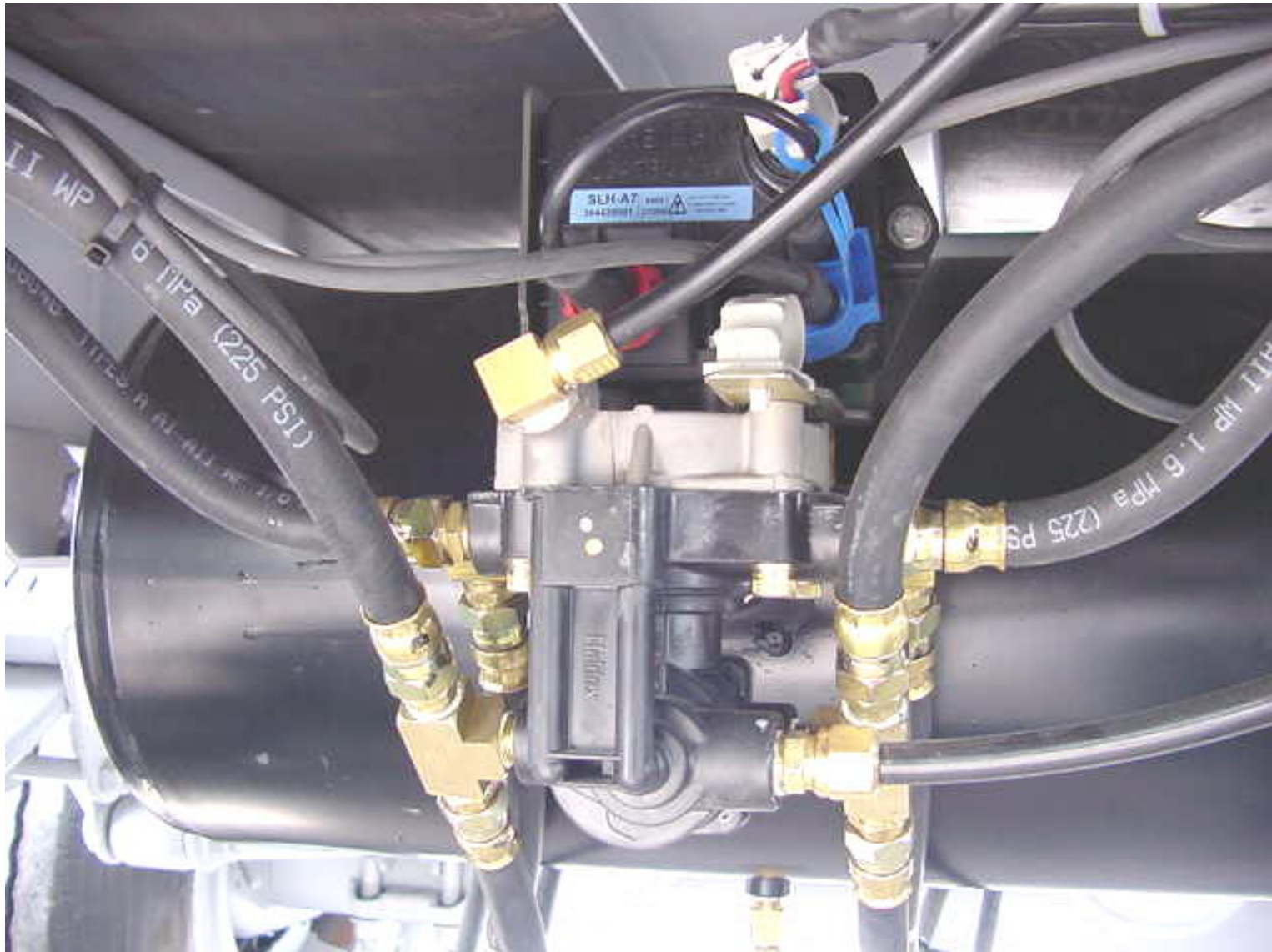

HALDEX TECH SUPPORT

**Technical Service
&
Engineering Support**

1-800-643-2374 (Press 2)

In Canada, please call

**Brake Systems Division
Haldex, Limited
525 Southgate Drive, Unit 1
Guelph, Ontario
Canada N1G 3W 6
1-800-267-9247**



BOLT ON 5TH WHEEL PLATE 4270442



FRONT FENDERS ARE THE
SAME LEFT AND RIGHT

FOR 54 INCH BELT TRAILER #
IS AUL-54 FRONT

REAR FENDERS ARE THE SAME
LEFT AND RIGHT

FOR 54 BELT TRAILER # IS
TANDEM IS AUL-54 TANDEM
TRIPLE IS AUL-54 TRIPLE
SPREAD IS AUL-54 SPREAD

FENDERS

ALUMINUM FENDERS

FRONT



REAR



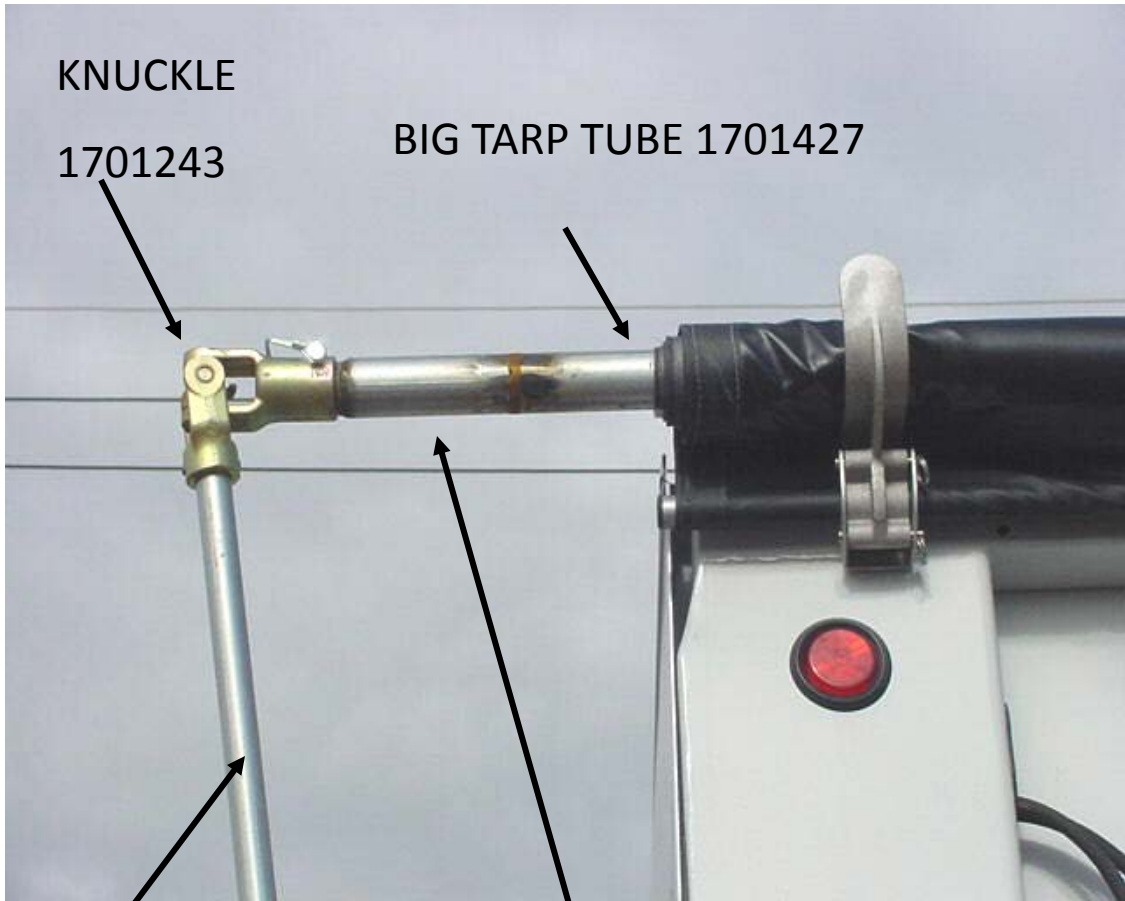

KNUCKLE

1701243

BIG TARP TUBE 1701427

CRANK TUBE 1100028

◀ WELD ON SPLINE 1107260

TARP KIT SHU1116642

42 FT TRAILER TARP SHU1900700

46 FT TRAILER TARP SHU1900701

48FT TRAILER TARP SHU1900702



REAR END CAP

1108983

CRANK HANDLE

1100171



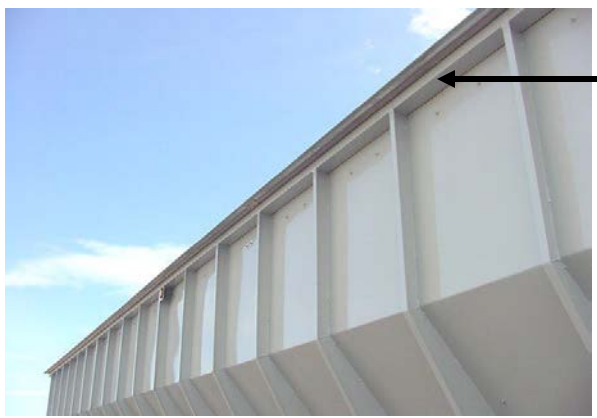
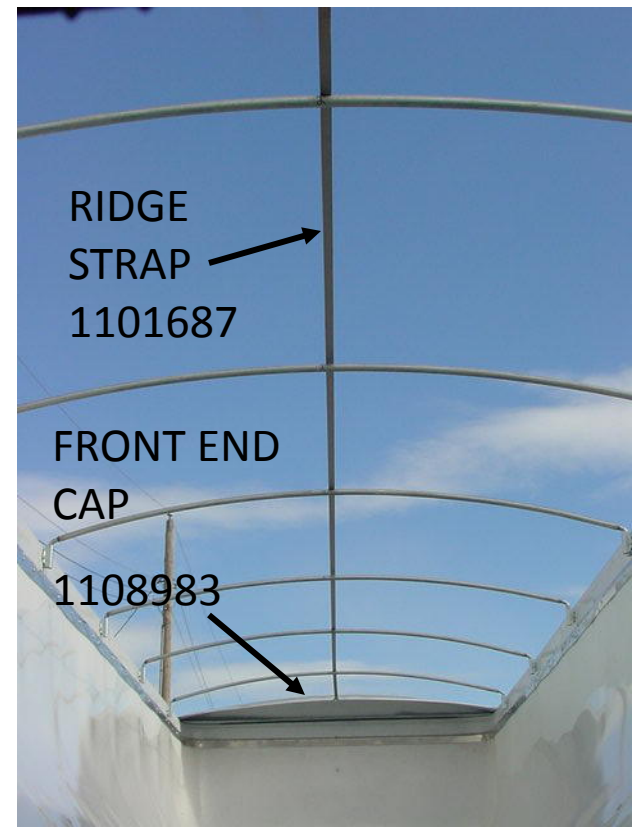
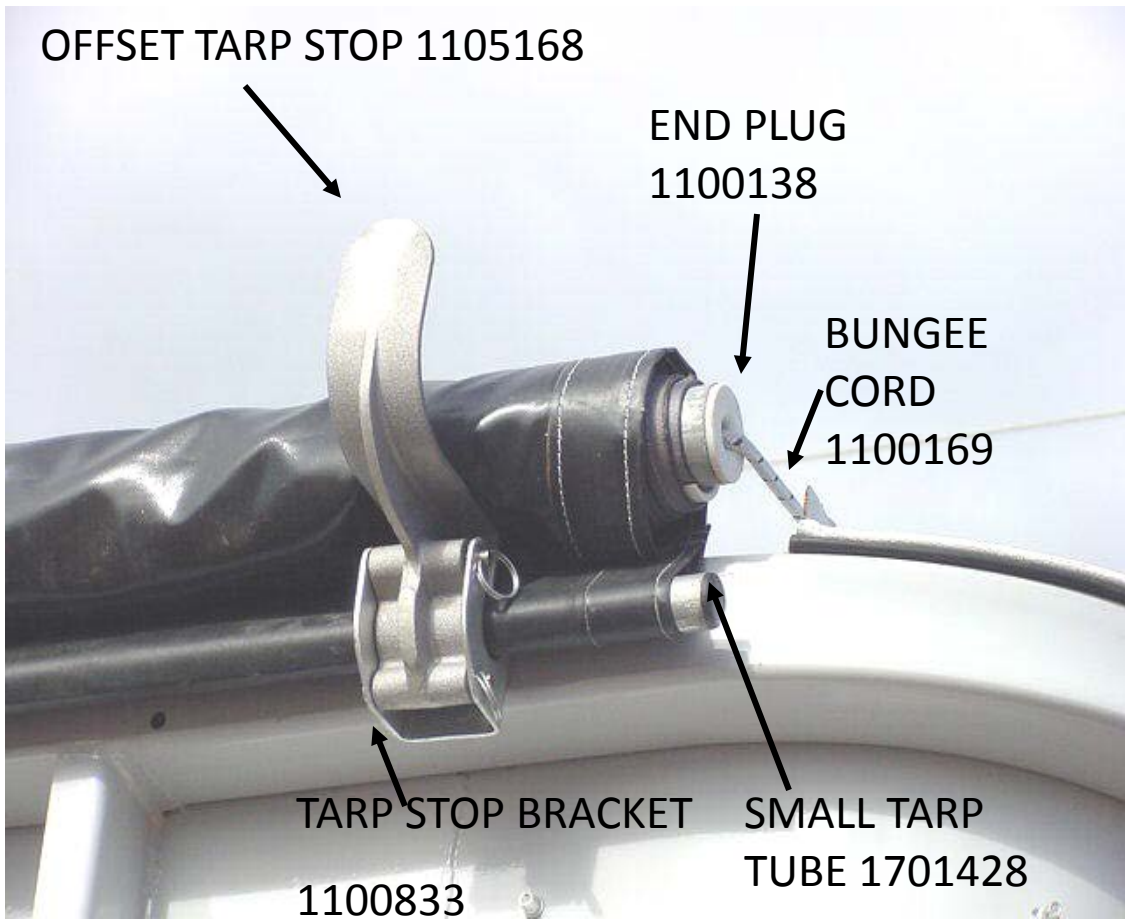

LATCH PLATE 1701548

TARP IS 18 OUNCE VINYL
 LENGTH VARIES BY
 TRAILER SIZE

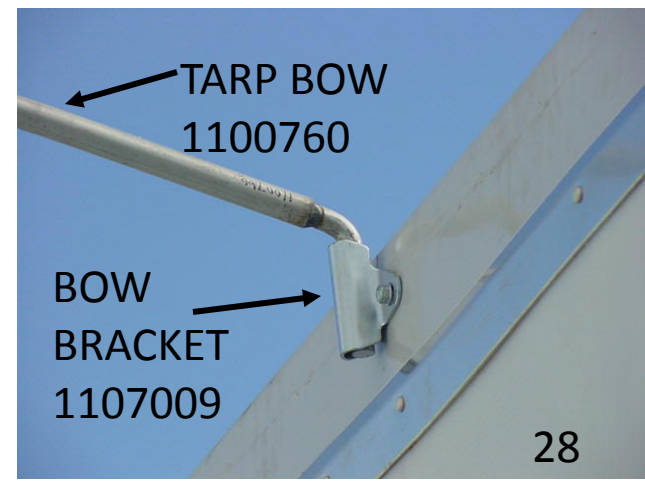

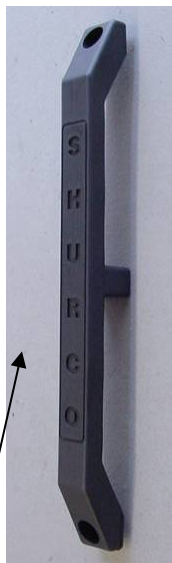
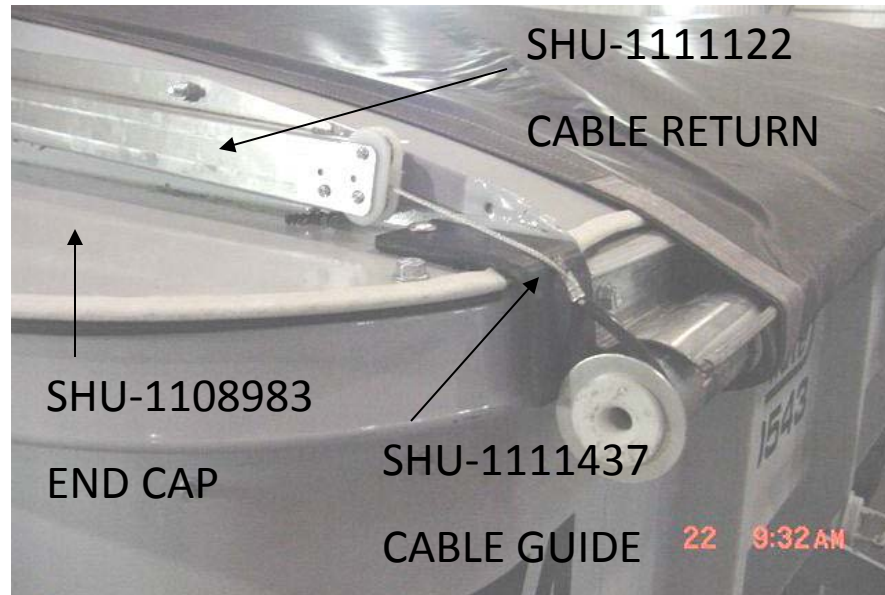

HD TARP BOWS, TARP SAVER AND CABLE RETURN ON FRONT FLEXABLE TARP STOP

ALUMINUM LADDER



EASY ACCESS FOR VIEWING INSIDE TRAILERS



Standard Specifications

- Floor Chain is 88C Drives Pintle Chain , 2 strands
- Easy access belt adjustment at front of trailer
- 2 Ply belt flaps full width of floor ,17.5 x 41 or 17.5 x 54
- Bolt on 5th Wheel
- Gear Drive is Eskridge Gear #9 , 130000 in-lb torque , 18000 pound radial load
- 2-15/16 diameter rear drive shaft , with weld on sprockets and splined hub
- Hydraulic Top hinge Main gate is 41 inches above top of trailer when open
- Plastic floor liner is UHMW 3/8 Thick, full width
- Plastic Side liner is HMW 3/16 Thick one piece , trailer is fully lined
- Extended rear discharge with wings on rear of trailer
- Mechanical latch on rear gate (operates with knife gate)
- Hydraulic pressure line filter with replaceable element
- Hydraulic Control Valve and Flow control mounted at left rear, pressure gauge
- Main Frame Rails are 10 inch i-beam , one piece , full length
- Sides of trailer only have one seam
- 50000 LB Landing Gear
- A B S brake system , 2S/1M anti/lock brake system Haldex
- Front and rear fenders
- 11 x 22.5 Radials on 10 bolt hub pilot rims
- Tandem axle
- 25000 LB axles, centrifuse drums, with 16.5 x 7 s-cam brakes with park brakes on both axles
- Hendrickson Intraax air ride suspension with Haldex quick acting leveling valve
- Trailer is sand blasted , Two part epoxy primer with 2 part polyurethane top coat
- D O T Lighting and reflective tape

AULICK INDUSTRIES

LIMITED WARRANTY POLICY

WARRANTY: Aulick Industries warrants that trailer model: _____, Serial number: _____ (hereinafter referred to as "Equipment") manufactured by Aulick Industries will be free from defects in materials and workmanship, provided that the Equipment warranted hereunder is operated by the purchaser in accordance with the practices approved by Aulick Industries with loads not exceeding the manufacturer's rated capacities and with loads that are not abrasive or corrosive in nature.

Aulick Industries sole obligation under this warranty shall be limited to repairing or replacing, at its option, in accordance with the schedule below, any defective part of the warranted Equipment, which shall be returned to Aulick Industries factory location or authorized service facilities and then Aulick Industries examination shall disclose to its satisfaction to have been defective; provided, however, that the purchaser notifies the Warranty Department immediately upon identification of defect, and such defective Equipment is returned by the purchaser to a Aulick Industries location authorized by the Warranty Department of Aulick Industries with transportation and freight charges prepaid within fifteen (15) days after discovery or defective conditions.

The customer shall not be required to deliver defective Equipment to Aulick Industries if the Equipment was destroyed as a result of defect covered in this warranty and the Aulick Industries Warranty Department is reasonably satisfied that the Equipment was defective at the time of the sale.

All labor and parts warranty must be authorized by Aulick Industries Warranty Manager. Failure to do so will result in no warranty payment of any kind.

THIS WARRANTY IS EXPRESSLY IN LIEU OF ALL OTHER WARRANTIES OF MATERIAL, WORKMANSHIP, DESIGN, APPLICATION OR OTHERWISE WITH RESPECT TO ANY EQUIPMENT, WHETHER EXPRESS OR IMPLIED, INCLUDING WARRANTIES OF MERCHANTABILITY AND FITNESS FOR A PARTICULAR PURPOSE, AND OF ALL OTHER OBLIGATIONS OR LIABILITIES ON THE PART OF AULICK INDUSTRIES.

Warranty Schedule Components and Structural

- I. Axles, Suspensions, Landing Gear, Wheels, Rims, Hydraulic components
Brakes ,and other manufactured items carry their own individual warranty

- II. Frame and all structural components , plastic liner , rear gate , knife gate , chain and flaps and rubber seals are warranted for one (1) Year from date of purchase on New trailers



14-R1745

AUlimate
4870543